



# 规格书 SPECIFICATIONS

客户名称: \_\_\_\_\_

Customer Name

客户品号: \_\_\_\_\_

Customer P/N

公司型号: DZ-1608GHKP-FCM-A00G

Factory Model

送样日期: \_\_\_\_\_

Sending Date

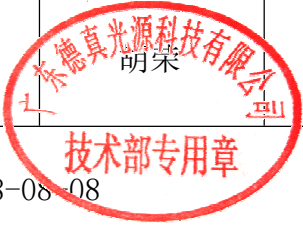
客户审核 Client approval			德真光源审核 Dezhen approval		
核准 Approval	确认 Audit	制作 Confirmation	核准 Approval	确认 Audit	制作 Confirmation
			柳欢		吴和钊
<input type="checkbox"/> 接受 Qualified		<input type="checkbox"/> 不接受 Disqualified	日期 DATE	2018-08-08	

地址: 惠州市仲恺高新区沥林镇中集智谷产业园 8 栋

Adr: Building 8, Zhongjizhi Valley Industrial Park, Lilin Town, Zhongkai High-tech Zone, Huizhou City

电话/Tel: 0752-8800515 传真/Fax: 0752-8800515

网址/Web: [www.dz-led.com](http://www.dz-led.com)



## 特点 Features

- 尺寸为 1.6\*0.8\*0.67mm Size: 1.6\*0.8\*0.67mm
- 发光角度宽 Extremely wide viewing angle
- 符合 ROHS 认证 ROHS compliant
- 低功耗 Low power consumption
- 颜色:绿光 Color :Green

## 应用 Applications

LCD 背光、转换器，开关和标志，显示、仪表盘等领域

Backlight for LCD, switch and Symbol, display、Instrument backlight

## 封装尺寸 Package Dimensions

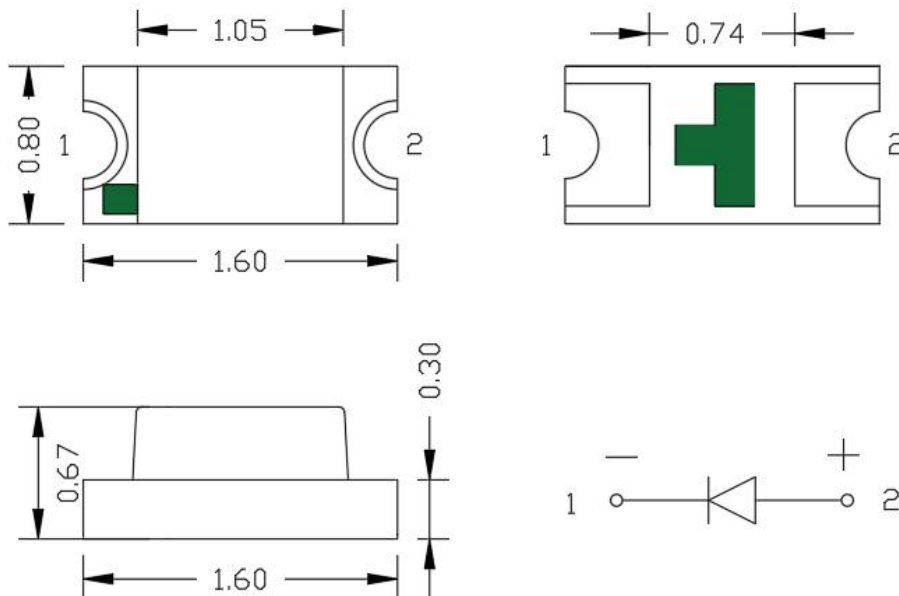

### 建议焊盘尺寸图 Recommended Soldering Pattern

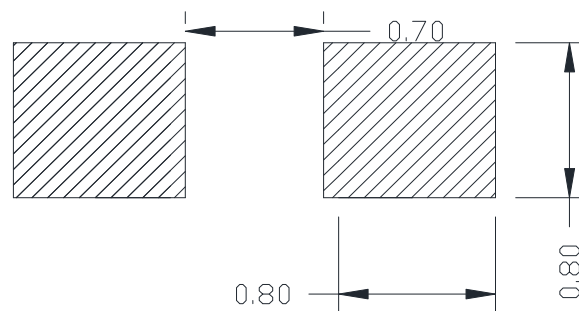

### 备注 Notes:

所有标注尺寸单位为毫米 (All dimension units are millimeters)

除特别注明外，所有尺寸均公差±0.1mm (Tolerance is ±0.1mm unless otherwise noted)

**最大限定参数 Absolute Maximum Ratings(Ta=25°C)**

项目名称 Parameter	符号 Symbol	规格 Value	单位 Unit
消耗功率 Power dissipation	Pd	95	mW
正向电流 Forward current	If	30	mA
反向电压 Reverse voltage	Vr	5	V
工作温度范围 Operating temperature range	Top	-35 ~+85	°C
储存温度范围 Storage temperature range	Tstg	-40 ~+85	°C
正向脉冲电流 Pulse Forward Current	Ifp	100	mA

**主要光电参数 Electro-optical characteristics(Ta=25°C)**

项目名称 Parameter	测试条件 Test Condition	项目符号 Symbol	最小值 MIN.	中间值 TYP.	最大值 MAX.	单位 Unit
正向电压 Forward voltage	If=2mA	VF	2.7	--	3.4	V
光强 Luminous Intensity	If=20mA	IV	1000	--	1600	mcd
角度 Viewing Angle	If=20mA	2 θ 1/2	--	120	--	Deg
反向电流 Reverse current	Vr=10V	IR	--	--	1	μA
主波长 Dominate Wavelength	If=20mA	λd	515	--	525	nm
抗静电能力(HBM)/设备: ZOYER Electrostatic Discharge(HBM)	放电间隔≥1 秒, 正反各 3 次	ESD	>3000			V

**备注 Notes:**

公差:光强 ±15%,主波长±2nm, 正向电压±0.1V, 色坐标 X, Y ±0.01

Tolerance:IV±15%, λd±2nm, Vf±0.1V, X, Y ±0.01

峰值电流条件: 脉冲范围 ≤ 10 毫秒, 占空比 ≤ 1/10.

IFP Conditions: Pulse Width ≤ 10msec and Duty ≤ 1/10.

典型光学特性曲线 Typical optical characteristics curves

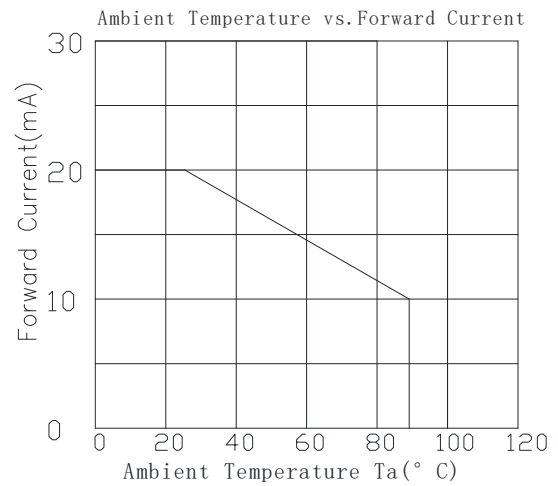
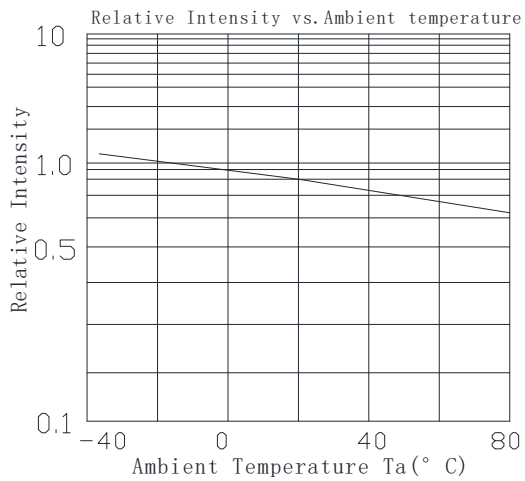
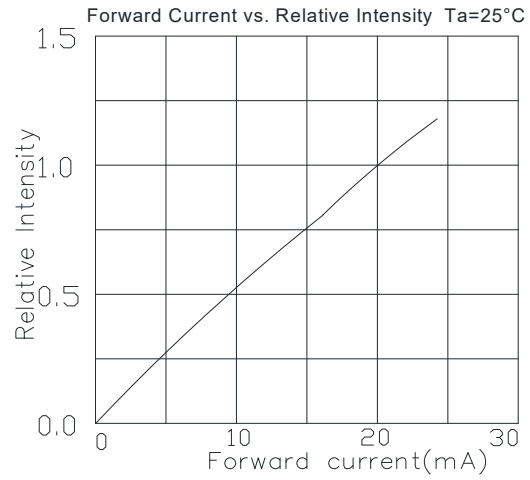
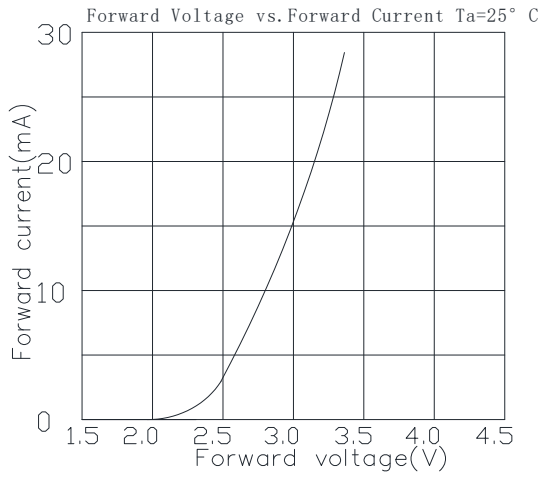

Curves of beam angle and relative brightness

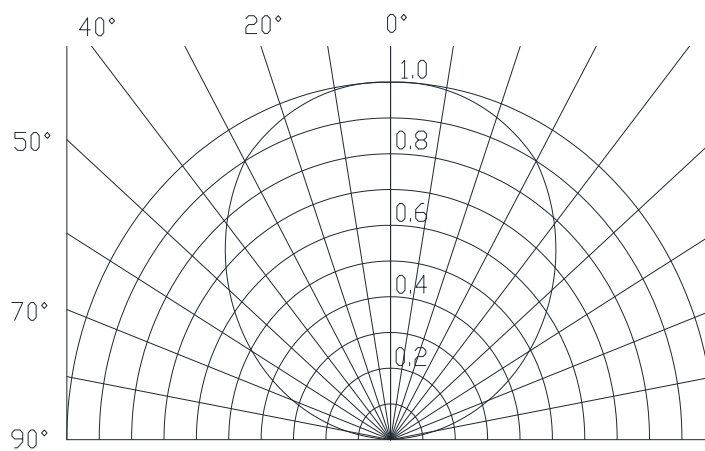

分光等级 Bin Rank

亮度范围 (If=20mA)

IV bin limit (If=20mA)

	Min.(mcd)	Max.( mcd )
IV	1000	1200
	1200	1400
	1400	1600

电压范围 (If=20mA)

VF bin limit (If=20mA)

	Min.(V)	Max.(V)
VF	2.7	2.8
	2.8	2.9
	2.9	3.0
	3.0	3.1
	3.1	3.2
	3.2	3.3
	3.3	3.4

波长范围 (If=20mA)

$\lambda$ d bin limit (If=20mA)

	Min.(nm)	Max.( nm )
$\lambda$ d	515	517.5
	517.5	520
	520	522.5
	522.5	525



信赖性测试项目及条件 Reliability Test Items And Conditions

项目 Test Items	参考标准 Ref.Standard	测试条件 Test Condition	时间 Time	数量 Quantity
回流焊 Reflow	JESD22-B106	Temp:260°C max T=10 sec	3 times.	20Pcs.
冷热冲击 Thermal Shock	JESD22-A104	125°C±5°C 15 min. ↑↓10sec -45°C±5°C 15 min.	300 Cycles	20Pcs.
高温保存 High Temperature Storage	JESD22-A103	Temp:100°C±5°C	1000Hrs.	20Pcs.
低温保存 Low Temperature Storage	JESD22-A119	Temp:-40°C±5°C	1000Hrs.	20Pcs.
常温通电 Life Test	JESD22-A108	Ta=25°C±5°C IF=20mA	1000Hrs.	20Pcs.
高温高湿保存 High Temperature High Humidity	JESD22-A101	85°C±5°C/ 85%RH	1000Hrs.	20Pcs.

失效判定标准 Criteria For Judging Damage

项目 Test Items	符号 Symbol	测试条件 Test Condition	判定标准 Criteria For Judgement	
			最小 Min.	最大 Max.
正向电压 Forward Voltage	VF	IF=20mA	--	U.S.L*)x1.1
反向电流 Reverse Current	IR	VR = 5V	--	U.S.L*)x2.0
光强 Luminous Intensity	IV	IF=20mA	L.S.L*)x0.7	--

规格上限 U.S.L: Upper standard level

规格下限 L.S.L: Lower standard level

数据工作表中所示的技术信息仅限于典型特征和电路实例引用的产品，它既不构成工业特性的保证，也不构成任何许可的授权。

\*The technical information shown in the data sheets are limited to the typical characteristics and circuit examples of the referenced products. It does not constitute the warranting of industrial property nor the granting of any license.

## 包装 Packaging

### 1. 载带尺寸 Carrier Tape Dimension

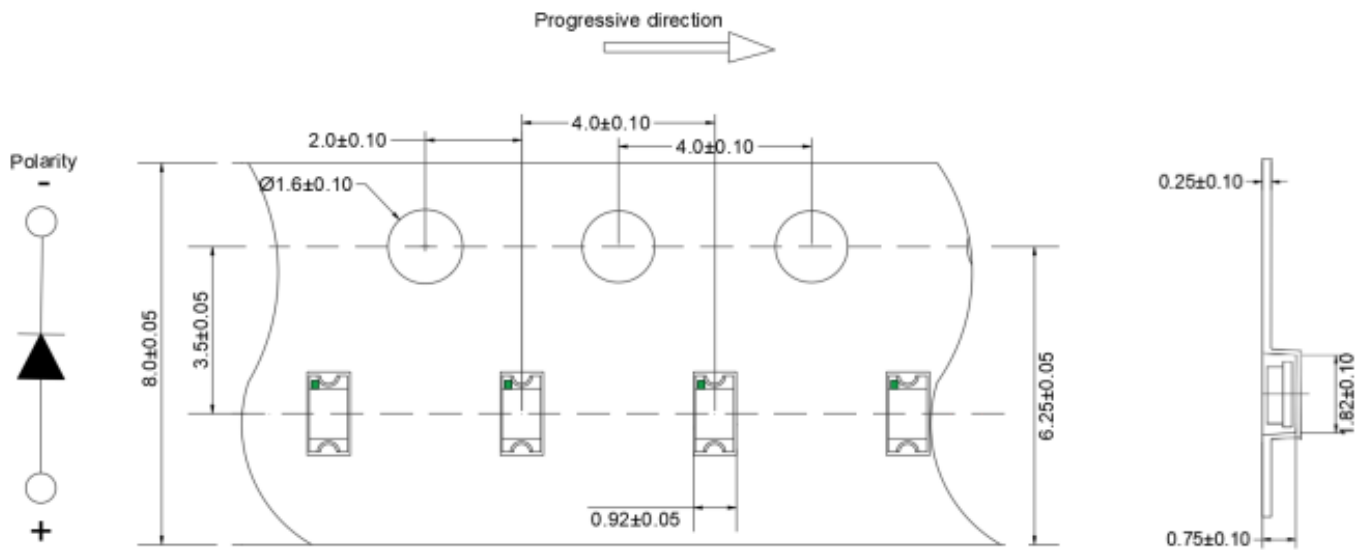

### 2. 卷盘尺寸及进料方向 Reel size and feed direction

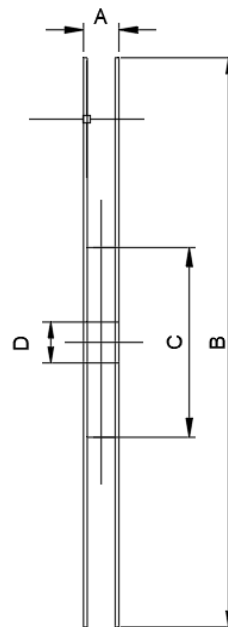
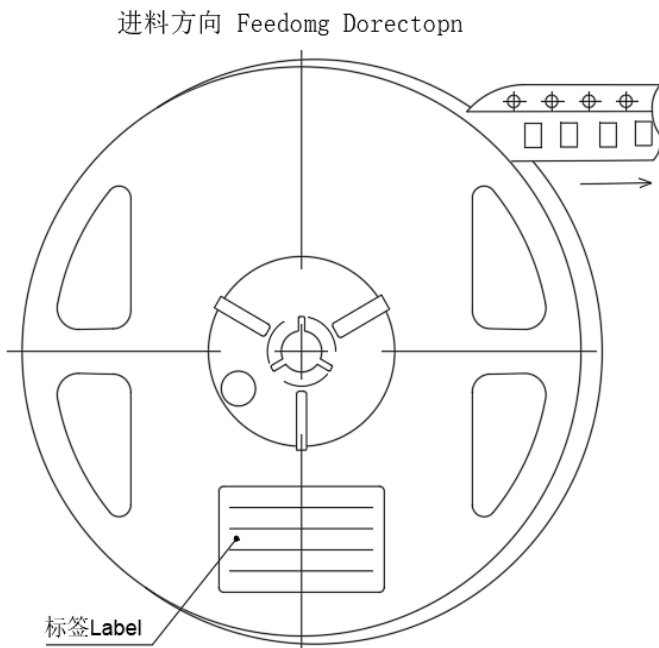

卷盘尺寸 Reel Dimension

A	$9.3 \pm 0.8$ mm
B	$178 \pm 1$ mm
C	$60 \pm 1$ mm
D	$13.5 \pm 0.5$ mm



### 3. 防潮包装 Moisture Resistant Packing

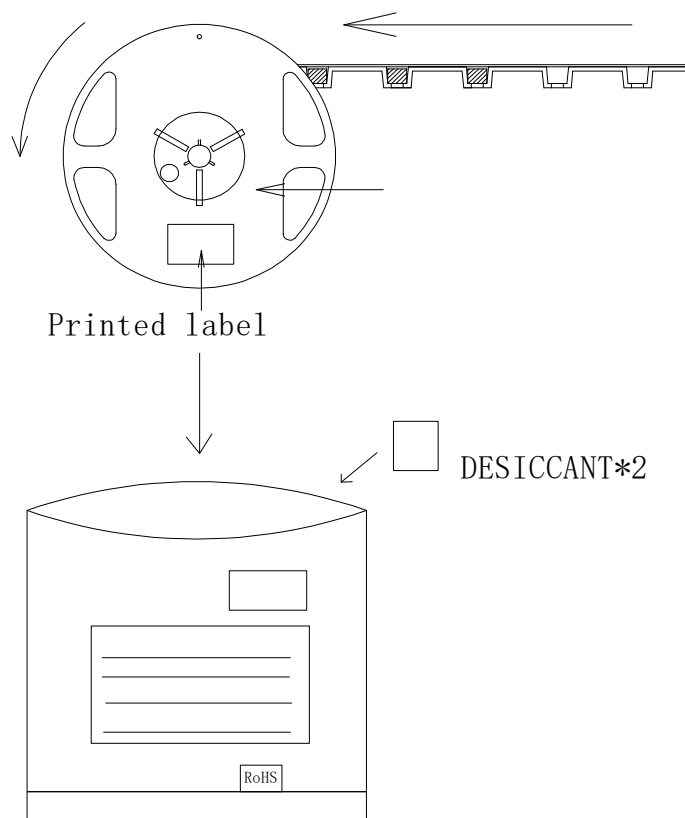

### 4. 包装纸箱 Cardboard Box

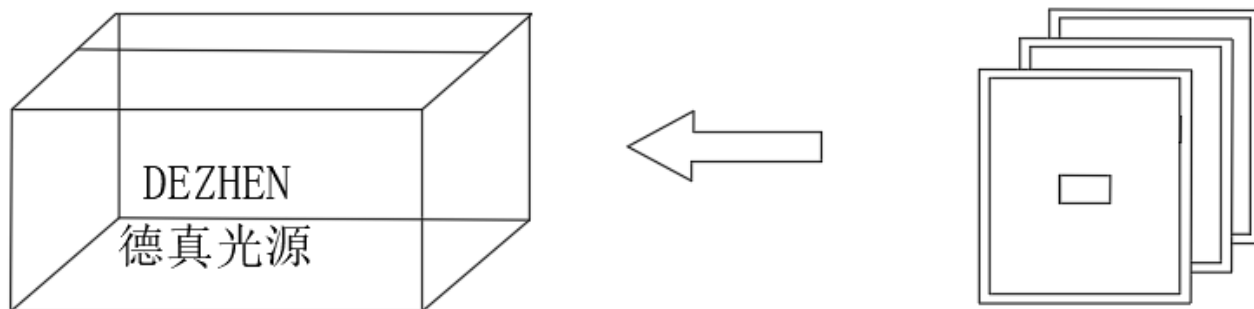

#### 备注 Notes:

1. 预留载带空位也贴有上封带  
Empty component pockets are sealed with top cover tape;
2. 最多缺失的 LED 不能超过两颗  
The maximum number of missing lamps is two;
3. 根据 ANSI/EIA RS-481 的规格,产品的负极指向卷带的导孔  
The cathode is oriented towards the tape sprocket hole in accordance with ANSI/EIA RS-481 specifications.
4. 5,000 颗/卷  
5,000 pcs / Reel.

## 应用及回流焊要求: Requirements for application and reflow soldering

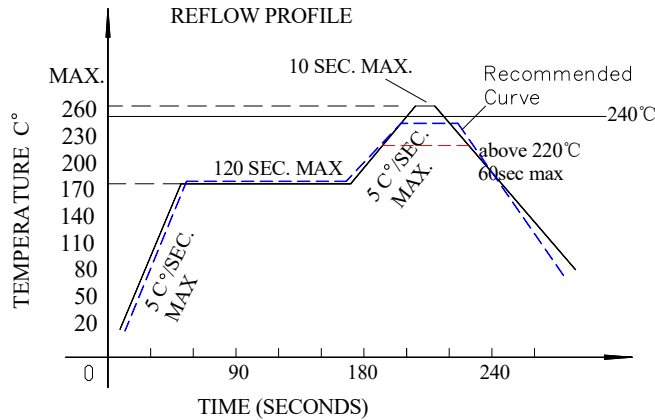

回流焊曲线图 Reflow soldering curve

产品最高可耐 260°C 回流焊，但建议最高温度设为 240°C

(Product is highest resistant to 260°C reflow but suggested the highest temperature of 240°C within)

### ■ 回流焊注意事项 Notes for reflow soldering:

1. 注意回流焊不可超过两次。

No more than twice for reflow soldering.

2. 在焊接时，不能在材料受热时用力压胶体表面。

When soldering, do not put stress on the LEDs during heating

3. SMT 后不要将组装好的 pcb 堆叠在一起，撞击可能会损伤胶体内部结构。

Do not stack together assembled PCBs containing LEDs. Impact may scratch the silicone lens or damage.



4. SMT 后如果还需要经过波峰焊，波峰焊温度建议使用 260°C 以内，并使用载具将灯珠避空。SMT 后须管控两道工序之间的时间不要超过 72 小时，超过 72 小时过波峰前须烘烤除湿，烘烤条件 60±5 °C 烘烤 24 小时处理。

If you also need to go through wave soldering after SMT, the wave soldering temperature is recommended to use within 260°C, and use fixtures to avoid the lamp bead. It is necessary to control the time between the two processes not more than 72 hours, more than 72 hours before the wave peak must be baked dehumidification, baking conditions of 60±5°C baking for 24 hours.

5. 如 SMT 存在双面锡膏回流工艺，须先贴电阻电容面，后贴灯珠面，以减少 LED 多次高温受损。

If SMT has a double-sided solder paste reflow process, the resistance capacitor surface must be affixed first and the lamp bead surface must be affixed. To reduce LED multiple high temperature damage.

6. LED 工作环境及与 LED 适配的材料中硫元素及化合物成份不可超过 25PPM。

LED operating environment and sulfur element composition cannot be over 25 PPM in the LED mating usage material.

## ■ 烙铁焊接 Soldering iron

1. 手工焊接时，要保持电烙铁温度在 300 摄氏度以下，并且焊接时间小于 3 秒，电烙铁不可接触胶体。

During the soldering, the electronic soldering iron must be kept under the temperature of 300 °C and the soldering time must not be beyond 3 seconds. No touch between the electronic soldering iron and colloid.

2. 手工焊接只可进行一次。Handwork soldering is only allowed once.
3. 避免使用尖锐的物体直接接触产品胶体部分。

Avoid using sharp objects to compress products Colloidal Part directly.

## 备注 Notes

1. 超过绝对最大额定值特别是正向电流和结温会损坏 LED 晶片；

Stresses in excess of the absolute maximum ratings such as forward current and junction temperature may cause damage to the LED.

2. 本产品非设计于逆向电流（电压）下使用，请在正向电流（电压下）使用；

This product should be operated in forward current (forward bias).

3. 静电或峰值浪涌电压会损坏 LED，避免在开灯、关灯时产生瞬时电压。

Static and Peak surge voltage can destroy LED, Avoiding Instantaneous voltage when turn on or turn off the lights

4. 使用时请佩带防静电手环，工作台做好防静电处理，机台设备等保证接地。

Please put on the antistatic hand loop during the use. The worktable should be with antistatic finish. The equipments must be contacted with ground.

5. 运输和储存需用防静电袋包装。

Use anti-static packaging for transport and storage.

## 储存 Storage

1. 未拆封前在 5°C~30°C，最大相对湿度 60%RH 的环境以下，储存时间为 1 年。

Storage condition before opening the package: 5 °C ~30 °C , the largest percentage relative humidity is 60%RH and the storage period is one year.

2. 开封后，LED 在 ≤30°C, ≤60%RH 相对湿度的条件下，必须在 48 小时内用完，未用完的产品重新真空密封，并放置在一个密封容器中，同时必须使用干燥剂。存储超过 7 天，下次使用时同样需要进行除湿操作，除湿条件为 60±5°C 24 小时。

The SMD LEDs should be used with 48 hours in condition of temperature no more than 30 °C and humidity no more than 60%RH. The rest products should be pressurized in vacuum condition with desiccants. Stored for more than 7 days, next time also must be dehumidification, the dehumidification conditions is 60±5 °C with 24hours.

## 清洗 Cleaning

1. 建议使用异丙醇、纯酒精擦拭，不要超过 1 分钟，在室温下放置 15 分钟后再使用。

Recommended to be wiped with isopropyl alcohol or pure alcohol, wiping time should not be more than one minute. LED must be placed at room temperature for fifteen minutes before using.

2. LED 不能接触丙酮、天那水、硫化物、酸、碱类，这些物质会损伤 LED。

LED can not be in contact with acetone, isoamyl acetate, sulfide, acid, alkali. These matter can destroy LED.