



规格书 SPECIFICATIONS

客户名称: _____

Customer Name

客户品号: _____

Customer P/N

公司型号: DZ-T05YY2-FLM-Y010

Factory Model

送样日期: _____

Sending Date

客户审核 Client approval			德真光源审核 Dezhen approval		
核准 Approval	确认 Audit	制作 Confirmation	核准 Approval	确认 Audit	制作 Confirmation
			柳欢	胡荣	林叶展
<input type="checkbox"/> 接受 Qualified		<input type="checkbox"/> 不接受 Disqualified		日期: 2023. 8. 29 DATE	



地址: 惠州市仲恺高新区沥林镇中集智谷产业园 8 栋

Adr: Building 8, Zhongjizhi Valley Industrial Park, Lilin Town, Zhongkai High-tech Zone, Huizhou City

电话/Tel: 0752-8800515 传真/Fax: 0752-8800515

网址/Web: www.dz-led.com

特点 Features

- 封装尺寸: $\Phi 5\text{mm}$ Size: diameter of 5mm
- 使用寿命长 long service life
- 低功耗 Low power consumption
- 符合 ROHS 认证 ROHS compliant
- 颜色: 黄光 Color : Yellow
- 胶体颜色: 透明 Colloidal color: Transpare

应用 Applications

LCD 背光、转换器, 开关和标志, 显示、仪表盘等领域

Backlight for LCD, switch and Symbol, display、Instrument backlight

封装尺寸 Package Dimensions

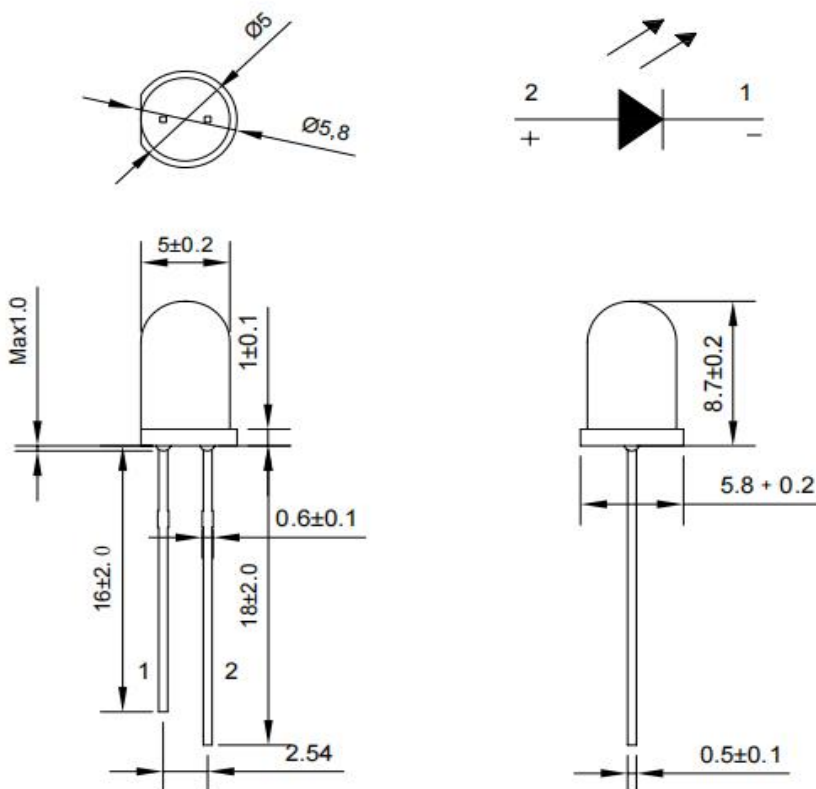

备注 Notes:

所有标注尺寸单位为毫米 (All dimension units are millimeters)

引脚的尺寸公差为 $\pm 1.5\text{mm}$, 胶体宽度公差为 $\pm 0.2\text{mm}$

The pin size tolerance is $\pm 1.5\text{mm}$, the colloidal width tolerance is $\pm 0.2\text{mm}$



最大限定参数 (Absolute Maximum Ratings)(Ta=25°C)

项目名称 Parameter	符号 Symbol	规格 Value	单位 Unit
消耗功率 Power dissipation	Pd	75	mW
正向电流 Forward current	If	30	mA
反向电压 Reverse voltage	Vr	5	V
工作温度范围 Operating temperature range	Top	-35 ~+85	°C
储存温度范围 Storage temperature range	Tstg	-40 ~+85	°C
正向脉冲电流 Pulse Forward Current	Ifp	100	mA

主要光电参数 (Electro-optical characteristics)(Ta=25°C)

项目名称 Parameter	测试条件 Test Condition	项目符号 Symbol	最小值 MIN.	中间值 TYP.	最大值 MAX.	单位 Unit
正向电压 Forward voltage	If=20mA	VF	1.7	--	2.5	V
光强 Luminous Intensity	If=20mA	IV	4000	--	10000	mcd
反向电流 Reverse current	Vr=5V	IR	--	--	1	μA
主波长 Dominate Wavelength	If=20mA	λd	585	--	595	nm
角度 Viewing Angle	If=20mA	2 θ 1/2	--	32	--	Deg
抗静电能力 (HBM) /设备: ZOYER Electrostatic Discharge(HBM)	放电间隔≥1 秒, 正反各 3 次	ESD	>2000			V

备注 Notes:

公差:光强 ±10%,主波长±2nm, 正向电压±0.05V

Tolerance:IV±10%, λd±2nm, Vf±0.05V

峰值电流条件: 脉冲范围 ≤ 10 毫秒, 占空比 ≤ 1/10.

IFP Conditions: Pulse Width ≤ 10msec and Duty ≤ 1/10.

典型光学特性曲线 Typical optical characteristics curves

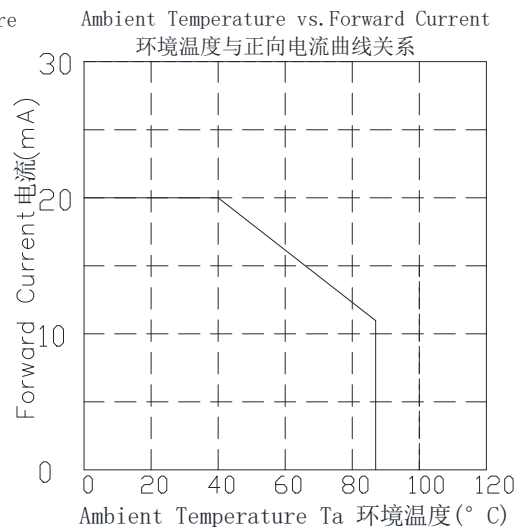
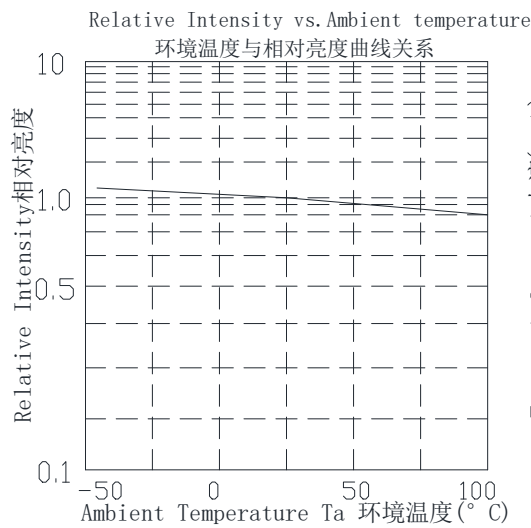
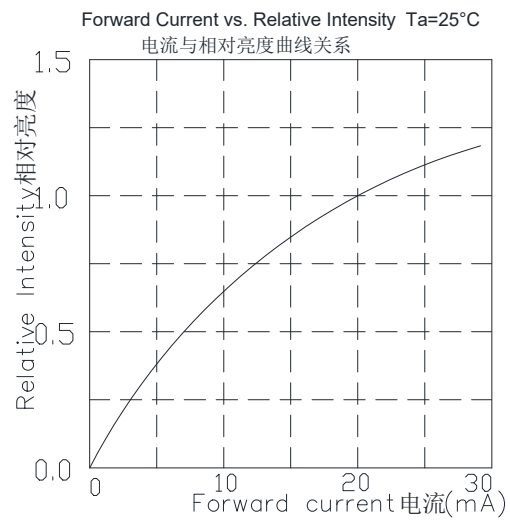
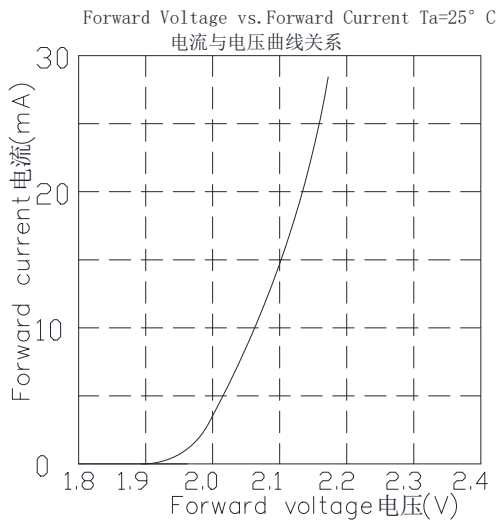

Cur ves of beam angle and relative brightness

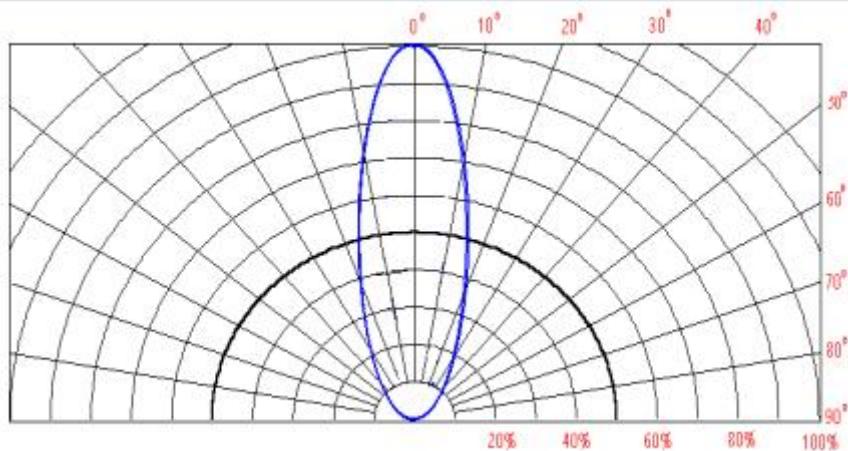

包装 Packaging

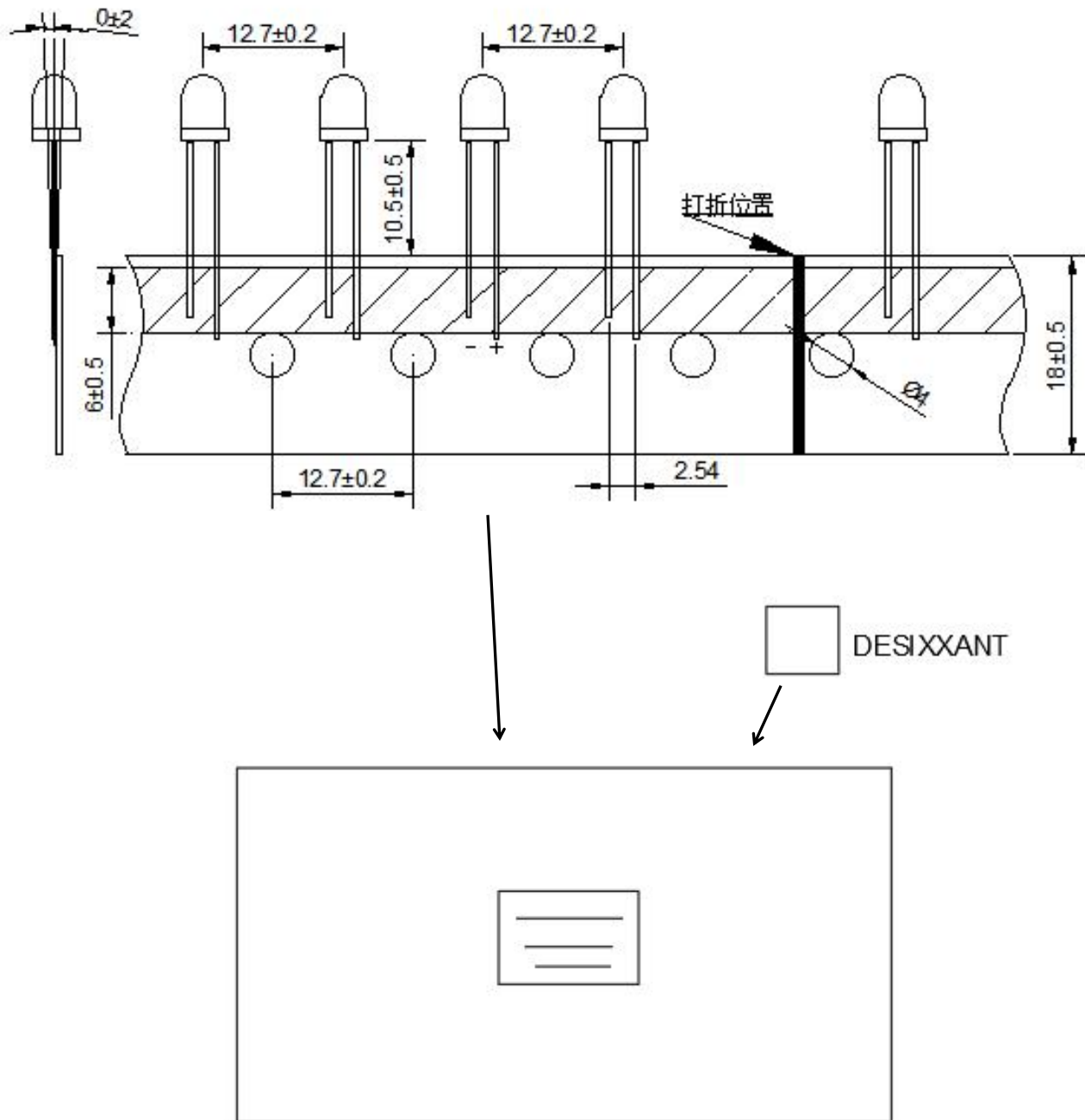

备注 Notes:

1. 预留载带空位也贴有上封带
 Empty component pockets are sealed with top cover tape;
2. 最多缺失的LED不能超过两颗
 The maximum number of missing lamps is two;
3. 2000颗/卷
 2000 pcs / Reel.



信赖性测试项目及条件 Reliability Test Items And Conditions

项目 Test Items	参考标准 Ref.Standard	测试条件 Test Condition	时间 Time	数量 Quantity
冷热冲击 Thermal Shock	JESD22-A104	125°C±5°C 15 min. ↑↓10sec -45°C±5°C 15 min.	300 Cycles	20Pcs.
高温保存 High Temperature Storage	JESD22-A103	Temp:100°C±5°C	1000Hrs.	20Pcs.
低温保存 Low Temperature Storage	JESD22-A119	Temp:-40°C±5°C	1000Hrs.	20Pcs.
常温通电 Life Test	JESD22-A108	Ta=25°C±5°C IF=20mA	1000Hrs.	20Pcs.
高温高湿保存 High Temperature High Humidity	JESD22-A101	85°C±5°C/ 85%RH	1000Hrs.	20Pcs.

失效判定标准 Criteria For Judging Damage

项目 Test Items	符号 Symbol	测试条件 Test Condition	判定标准 Criteria For Judgement	
			最小 Min.	最大 Max.
正向电压 Forward Voltage	VF	IF=20mA	--	U.S.L*)x1.1
反向电流 Reverse Current	IR	VR = 5V	--	U.S.L*)x2.0
光强 Luminous Intensity	IV	IF=20mA	L.S.L*)x0.7	--

规格上限 U.S.L: Upper standard level

规格下限 L.S.L: Lower standard level

数据工作表中所示的技术信息仅限于典型特征和电路实例引用的产品，它既不构成工业特性的保证，也不构成任何许可的授权。

*The technical information shown in the data sheets are limited to the typical characteristics and circuit examples of the referenced products. It does not constitute the warranting of industrial property nor the granting of any license.

应用注意事项 Precautions for use**■ 焊接条件 Welding conditions**

1. 请在离树脂底部 2mm 以上进行焊接。

Please solder more than 2mm from the bottom of the resin.

2. 烙铁：请在 30W 以下 3S 内进行 1 次焊接。

Soldering iron, Please do 1 welding within 3S below 30W.

3. 请避免树脂部分浸入锡槽，浸焊后请避免矫正位置。

Please avoid the resin part immersed in the tin bath, and please avoid correcting the position after dipping.

4. 焊接时在引线架被加热的状态下请不要施加压力。

Please do not apply pressure when the lead frame is heated during soldering.

■ 引线架的成型及切割 Forming and cutting of lead frames

1. 成型位置请在卡点以下部分进行，成型时请不要向封装外壳施加压力，成型请在焊接前进行。

The molding position should be carried out at the part below the clamping point. Please do not apply pressure to the package shell during molding. Please do the molding before soldering.

2. 产品在高温的状态下进行引脚裁切会对元件造成损害，请在常温下进行引脚裁切

If the product is cut at high temperature, it will cause damage to the components. Please cut the lead at room temperature.

■ 安装 Install

1. 请不要在引线架施加压力的状态下安装

Please do not install with the lead frame under pressure

2. 在电路板上安装时，安装孔距请与引线架保持一致

When installing on the circuit board, please keep the installation hole spacing consistent with the lead frame

3. 超过绝对最大额定值特别是正向电流和结温会损坏 LED 晶片；

Stresses in excess of the absolute maximum ratings such as forward current and junction temperature may cause damage to the LED.

4. 本产品非设计于逆向电流（电压）下使用，请在正向电流（电压下）使用；

This product should be operated in forward current (forward bias).

■ 防静电 anti-static

1. 本产品是对静电敏感的产品，在使用上需要十分注意。特别是在超过最大额定电流和电压时会

损害或破坏产品。在使用产品时请做好安全静电和电涌防护措施。

This product is sensitive to static electricity and requires great attention when using it. In particular, exceeding the maximum rated current and voltage can damage or destroy the product. Please take safe electrostatic and surge protection measures when using the product.

2.检查通电电路，电流开关时的电涌不要超过最大额定电流，对于驱动电路请插入适当的保护电路。

Check the energized circuit, the surge during current switching should not exceed the maximum rated current, and for the drive circuit, please insert an appropriate protection circuit

3.使用中静电和电涌的措施：人体接地（通过1兆欧姆）、导电性垫子、导电性工作服、导电性鞋和导电性容器都是比较有效果的。

Measures against static electricity and surges in use: grounding the human body (through 1 megohm), conductive mats, conductive work clothes, conductive shoes and conductive containers are all effective.

4.烙铁请注意接地。另外，对于容易发生静电的环节，推荐使用离子发生器

Please ground the soldering iron. In addition, it is recommended to use an ionizer for links that are prone to static electricity.

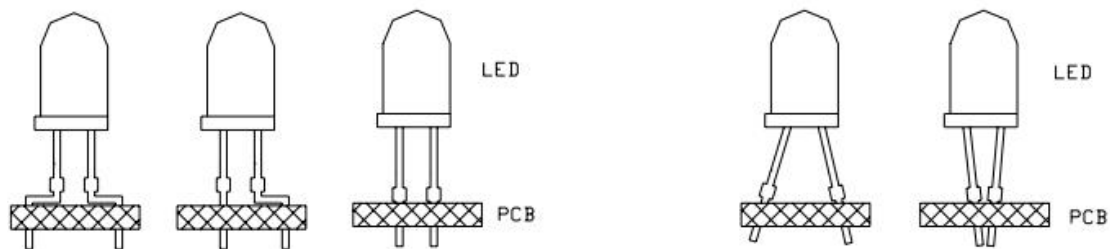

正确方式

错误方式

备注 Notes

1. 静电或峰值浪涌电压会损坏 LED，避免在开灯、关灯时产生瞬时电压。

Static and Peak surge voltage can destroy LED, Avoiding Instantaneous voltage when turn on or turn off the lights.

2. 使用时请佩带防静电手环，工作台做好防静电处理，机台设备等保证接地。

Please put on the antistatic hand loop during the use. The worktable should be with antistatic finish. The equipments must be contacted with ground.

3. 运输和储存需用防静电袋包装。

Use anti-static packaging for transport and storage.